



REA - Flusso orizzontale  
Horizontal discharge



Modelli con motori EC Brushless  
EC Brushless motors model



REV - Flusso verticale  
Vertical discharge

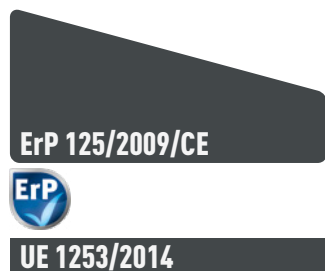

#### Conformi

Direttiva ErP 125/2009/CE  
e al Regolamento UE 1253/2014

#### Comply

ErP Directive 125/2009/CE  
and EU Regulation 1253/2014

# REA - REV

## Torrini d'estrazione centrifughi a rotore esterno

Centrifugal roof fans with external rotor motor



#### DESCRIZIONE

Torrini destinati all'aspirazione, diretta o canalizzata, nelle più svariate applicazioni civili, industriali e commerciali. Caratterizzati da una notevole semplicità d'installazione, si distinguono per l'elevata compattezza.

#### TEMPERATURA DI ESERCIZIO

Idonei ad aspirare aria pulita con temperature da -10°C a +60°C.

#### COSTRUZIONE

- Telaio di base in lamiera d'acciaio zincato.
- Rete di protezione in tondino d'acciaio trafilato e protetto contro gli agenti atmosferici.
- Girante a pale rovesce, ad alto rendimento aeraulico e bassa rumorosità, plastica PA.
- Copertura in alluminio (REA).
- Convogliatore in ABS (REV).

#### MOTORE

Motore a rotore esterno, trifase o monofase IP44 (modelli fino al 254) e IP54 per gli altri.

- **REA:** motori elettronici monofase.

#### ACCESSORI

- TS - Serranda a gravità in aspirazione
- GR - Silenziatore
- CB - Controbase a murare
- BA - Basi d'appoggio su coperture ondulate
- Regolatori di velocità e inverter
- PB - Base d'appoggio/riduzione silenziata, esclusa grandezza 200
- CCr - Rete di protezione piana.

#### DESCRIPTION

These fans are designed for direct or ducted ventilation of civil, commercial and industrial buildings. The characteristics of this series are the compact design and ease of installation.

#### OPERATING TEMPERATURE

Suitable for exhausting clean air with temperature from -10°C up to +60°C.

#### CONSTRUCTION

- Base frame in galvanized steel sheet.
- Protection guard in drawn steel rod protected against the atmospheric agents.
- Backward curved wheel in PA plastic with high efficiency and low noise level.
- Upper cover in aluminium (REA).
- Outer deflector (REV) in ABS.

#### MOTOR

External rotor motor, three-phase or single phase, IP44 (for models up to Size 254) and IP54 for the others.

- **REA:** single-phase, electronically controlled motors.

#### ACCESSORIES

- TS - Backdraught gravity shutter
- GR - Silencer
- CB - Counterbase to wall up
- BA - Support base for wawed roof coverings
- Speed regulators and inverters
- PB - Support base/Silenced reduction, not available for size 200
- CCr - Flat protection guard.

# PRESTAZIONI | PERFORMANCE

REA | REV

Le prestazioni aeruliche sono rilevate in conformità alla norma EN ISO 5801/AMCA 210 con densità dell'aria standard avente peso specifico 1,2 Kg/m<sup>3</sup>. Conformi alla Direttiva ErP 2009/125/CE e al regolamento UE1253/2014. Categoria di misura: C. Categoria di efficienza: Statica. Alimentazione 230V/1Ph/50Hz o 400V/3Ph/50Hz. In conformità al Regolamento UE 1253/2014 (2018), le Unità di Ventilazione a singolo flusso devono essere abbinate, al momento della messa in servizio, ad un azionamento a velocità multiple, kit local o equivalente. Air performances measured according to EN ISO 5801 / AMCA 210 standard with air density with 1.2 kg/m<sup>3</sup> specific weight. Compliant with ErP 2009/125/EC Directive and EU Regulation 1253/2014. Measurement category: C. Efficiency category: Static. Power supply 230V/1Ph/50Hz or 400V/3Ph/50Hz. In compliance with EU Regulation 1253/2014 (2018), the single flow Ventilation Units must be connected to a multiple speed regulation (local demand controller or equivalent) when put into service.

**Lp** Livello di pressione sonora rilevato in condizioni di campo libero, propagazione semisferica, categoria di misura C a norma EN ISO 13349, nel punto di massimo rendimento, alla distanza di 6 metri e si presenta solo per fini comparativi. Sound pressure level measured in free field conditions, propagation hemispherical, measurement category C in accordance with EN ISO 13349, at the point of maximum efficiency, at a distance of 6 meters (for comparative purposes only).

**Lw** Livello di potenza sonora ottenuto secondo norma ISO 3746. Tolleranza +/- 3 dB(A). Sound power level obtained in accordance with EN ISO 3746. Tolerance +/- 3 dB(A).

## REA 200

Code	Tipo Type	Modello Model	U	P	Pm (kW)	In (A)	IP/CL	dB(A)	
								Lw	Lp
1RE2042	REA	202	M	2	0,06	0,23	44/B	68	44

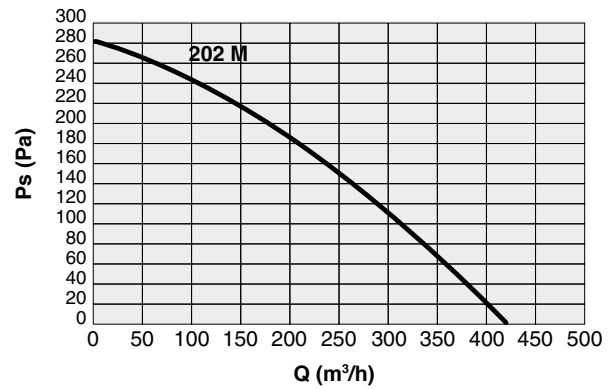

## REA - REV 250

Code	Tipo Type	Modello Model	U	P	Pm (kW)	In (A)	IP/CL	dB(A)	
								Lw	Lp
1RE2545	REA	252	M	2	0,20	0,68	44/B	77	53
1RE2544		254	M	4	0,12	0,39	44/B	66	43
1RV2550	REV	252	M	2	0,20	0,90	44/B	77	53
1RV2560		254	M	4	0,12	0,80	44/B	66	43

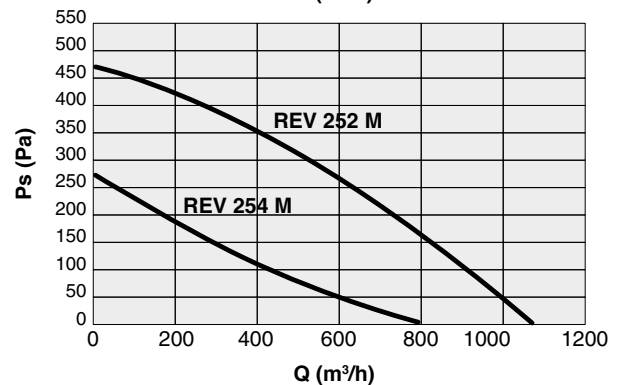
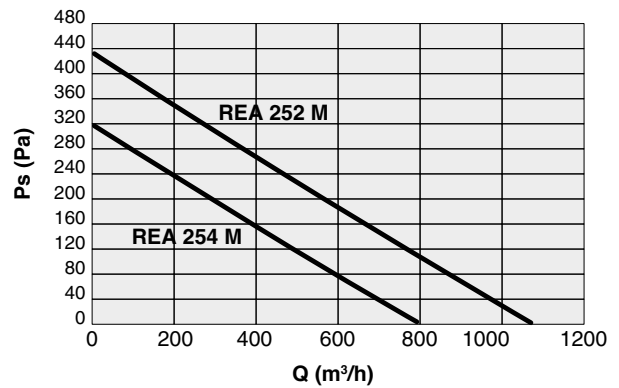

SEZ.

1.1

REA - REV torrini | roof

## REA - REV 310

Code	Tipo Type	Modello Model	U	P	Pm (kW)	In (A)	IP/CL	dB(A)	
								Lw	Lp
1RE0301	REA	314	M	4	0,22	1,10	54/F	61	37,5
1RE0300		314	T	4	0,22	0,50	54/F	61	37,5
1RV3151	REV	314	M	4	0,22	1,10	44/B	61	37,5
1RV3156		314	T	4	0,21	0,50	54/F	61	37,5

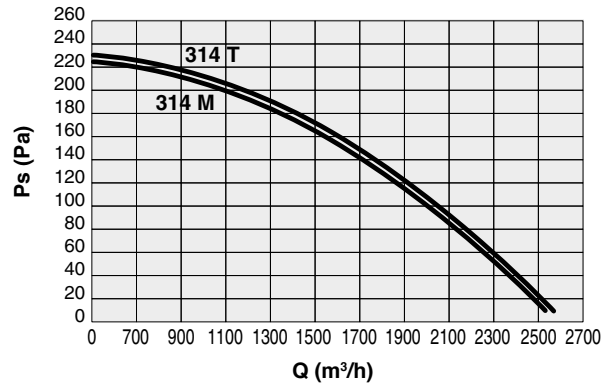

## REA - REV 350

Code	Tipo Type	Modello Model	U	P	Pm (kW)	In (A)	IP/CL	dB(A)	
								Lw	Lp
1RE0351	REA	354	M	4	0,58	2,60	54/F	67	43,5
1RE0350		354	T	4	0,33	0,68	54/F	63	39,5
1RV3551	REV	354	M	4	0,58	2,60	54/F	67	43,5
1RV3556		354	T	4	0,33	0,70	54/F	63	39,5

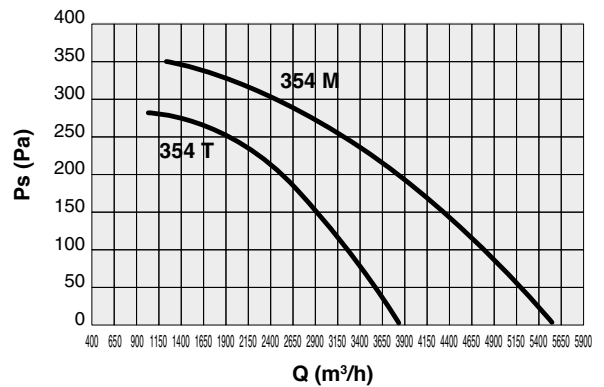

## REA - REV 400

Code	Tipo Type	Modello Model	U	P	Pm (kW)	In (A)	IP/CL	dB(A)	
								Lw	Lp
1RE0400	REA	404	T	4	0,54	1,20	54/F	67	43,5
1RV4056	REV	404	T	4	0,54	1,20	54/F	67	43,5

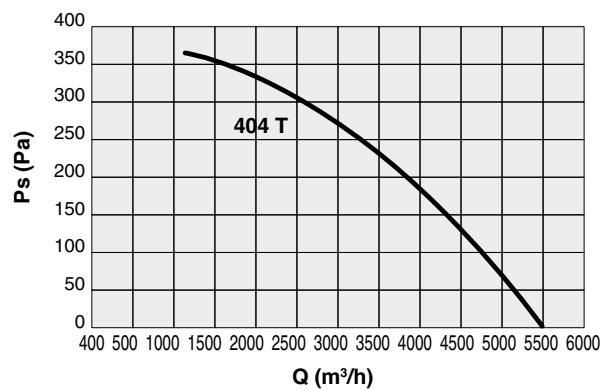



Versioni con motori EC Brushless  
EC Brushless motors versions

## REA 200 EC

Code	Tipo Type	Modello Model	U	Pm (kW)	In (A)	dB(A)	
						Lw	Lp
1RE2046	REA	200 EC	M	0,08	0,8	65	42

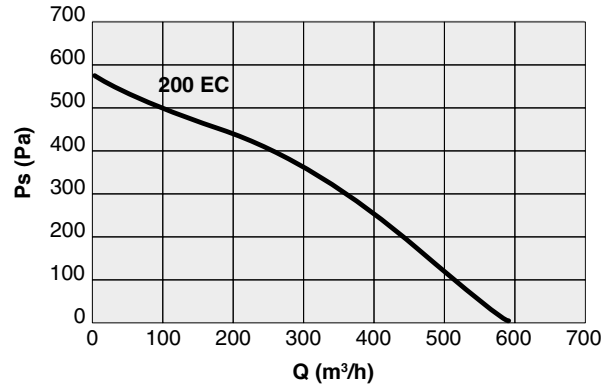

## REA 250 EC

Code	Tipo Type	Modello Model	U	Pm (kW)	In (A)	dB(A)	
						Lw	Lp
1RE2549	REA	250 A EC	M	0,17	1,4	77	53
1RE2550		250 B EC	M	0,08	0,8	78	54

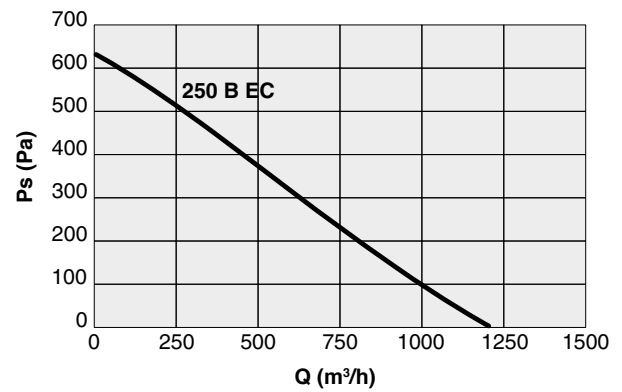
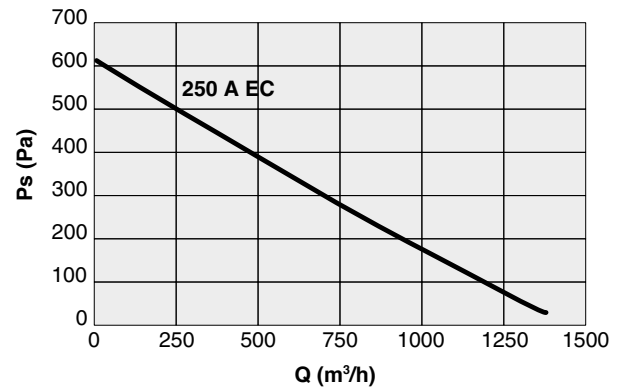

## REA 310 EC

Code	Tipo Type	Modello Model	U	Pm (kW)	In (A)	dB(A)	
						Lw	Lp
1RE0302	REA	310 EC	M	0,15	1,3	70	46

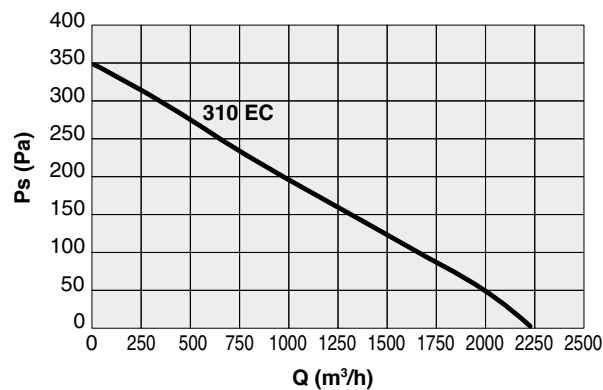

## REA 350 EC

Code	Tipo Type	Modello Model	U	Pm (kW)	In (A)	dB(A)	
						Lw	Lp
1RE0352	REA	350 EC	M	0,28	1,2	73	50

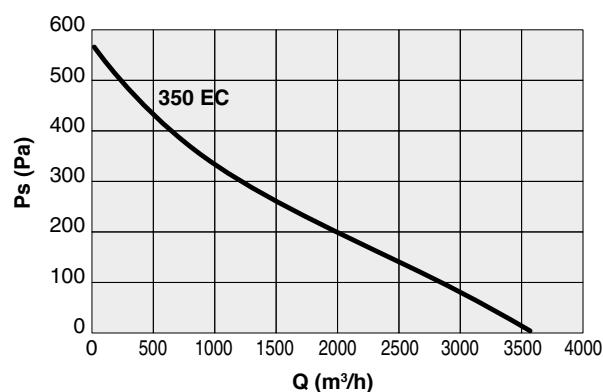

## REA 400 EC

Code	Tipo Type	Modello Model	U	Pm (kW)	In (A)	dB(A)	
						Lw	Lp
1RE0401	REA	400 EC	M	0,54	2,4	75	52

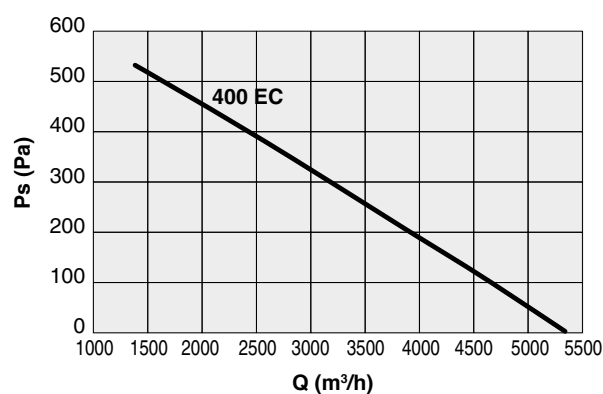

# DIMENSIONI | DIMENSIONS mm

REA | REV | REA EC 

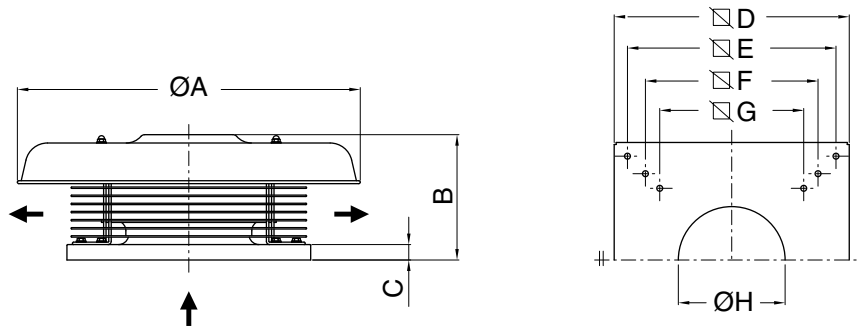

## REA

TIPO   TYPE	ØA	B	C	ØD	ØE	ØF	ØG	ØH	Kg
REA 200	395	180	23	300	265	-	220	125	6
REA 250	490	220	38	400	360	-	257	178	10
REA 310	555	310	38	400	360	-	307	220	14
REA 350	690	335	38	500	450	-	380	270	25
REA 400	810	360	38	650	600	530	471	296	40

Pesi indicativi | Indicative weights

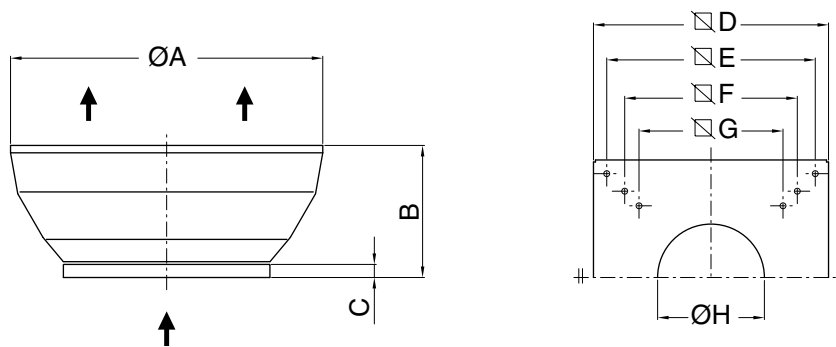

## REV

TIPO   TYPE	ØA	B	C	ØD	ØE	ØF	ØG	ØH	Kg
REV 250	650	290	38	400	360	-	257	178	10
REV 310	650	290	38	400	360	-	307	220	15
REV 350	800	340	38	500	450	-	380	270	32
REV 400	980	400	38	650	600	530	471	296	45

Pesi indicativi | Indicative weights

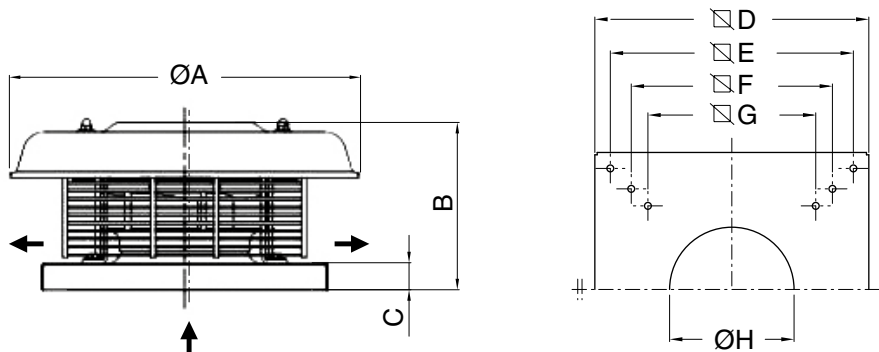

## REA EC

TIPO   TYPE	ØA	B	C	ØD	ØE	ØF	ØG	ØH	Kg
REA EC 200	395	200	23	300	265	-	220	125	6
REA EC 250	490	240	38	400	360	-	257	178	10
REA EC 310	555	340	38	400	360	-	307	220	14
REA EC 350	690	380	38	500	450	-	380	270	25
REA EC 400	810	400	38	650	600	530	471	296	40

Pesi indicativi | Indicative weights

sez.  
1.1

REA - REV torrini | roof



## GR | SILENZIATORI | SILENCERS

Silenziatori con setto centrale, riducono la rumorosità del torrino. Materiale fonoassorbente in lana minerale. Struttura portante in lamiera zincata. Attenzione: l'utilizzo del silenziatore abbinato alla serranda TS, l'utilizzo della versione con setto ribassato.

Silencers with central pod. They reduce the noise of the fan. Sound absorbing material: mineral wool. Frame in galvanized steel sheet. Attention: the use of a Silencer together with a TS shutter requires the use of the silencer with lowered pod.

Code (I)	Code (II)	Tipo Type	A	B	B ribassato lowered	C	D	E	F	G	ØH	Kg
1S10310	1S10456	GR 25-31	750	650	450	390	360	95	100	50	M8	28
1S10350	1S10457	GR 35	750	650	400	490	450	120	150	50	M8	37
1S10400	1S10454	GR 40	750	650	350	640	600	145	250	50	M8	42
1S10400	1S10454	GR 45	750	650	350	640	600	145	250	50	M8	42

(I) Versione standard | Standard version - (II) Versione con setto ribassato | Version with lowered pod

### ATTENUAZIONE IN dB PER BANDE DI OTTAVA (Hz) OCTAVE (Hz) SPECTRUM OF NOISE ATTENUATION IN dB

Tipo   Type	63	125	250	500	1000	2000	4000	8000
GR 25	2	4	6	10	16	18	15	11
GR 31	2	4	6	10	16	18	15	11
GR 35	3	5	9	11	19	20	18	14
GR 40	3	4	8	9	18	15	10	6
GR 45	3	4	8	9	18	15	10	6
GR 50	4	5	11	15	16	12	9	5
GR 56	4	5	11	15	16	12	9	5
GR 63	3	4	5	8	14	9	7	3
GR 75	3	4	5	8	14	9	7	3
GR 80	3	4	5	8	14	9	7	3

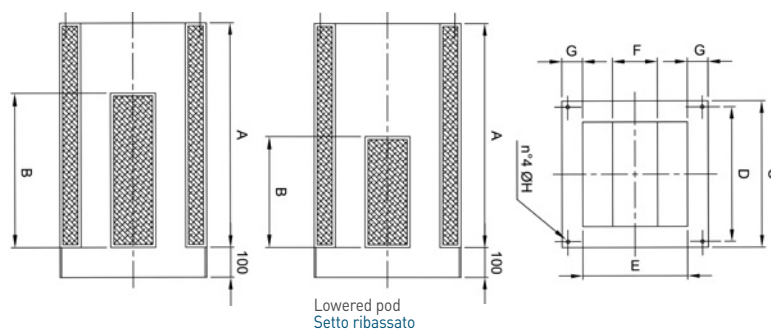

## TS | SERRANDE A GRAVITÀ | GRAVITY SHUTTER

Evitano inutili dispersioni di calore e richiedono un'irrelevante perdita di carico. Le alette della serranda si aprono con la depressione dell'aria generata dal ventilatore in moto e si chiudono per gravità al suo spegnimento. La struttura è realizzata in lamiera zincata. Nel caso di utilizzo con silenziatore, utilizzare la versione di silenziatore con setto ribassato.

They avoid heat dispersion through the roof when this fan is not working with a negligible opening pressure. The shutter flaps are opened by the air depression produced by the fan when working, and they shut down by gravity after switching-off. The structure is made in galvanized steel sheet. In case of use with silencer, the version of silencer with lowered pod has to be used.

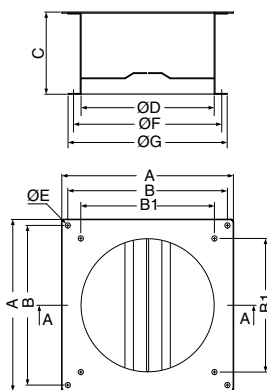

Code	Tipo   Type	A	B	B1	C	ØD	ØE	ØF	ØG	Kg
1TS2010	TS 20	240	220	-	110	161	10	177	185	1,5
1TS3010	TS 25/31	330	307	257	158	258	10	285	306	2,5
1TS3510 (I)	TS 35	465	380	-	222	402	10	438	464	5,0
1TS4010	TS 40/45	500	471	-	222	402	10	438	464	6,0

(I) Non compatibile con silenziatore 1S10350 o altri  
Not compatible with silencer 1S10350 or others

## CB | CONTROBASI A MURARE | COUNTER BASES TO BE WALLED UP

La controbase garantisce un efficace ancoraggio al cavedio, tramite la muratura delle quattro zanche appositamente realizzate. Manufatto realizzato in robusta lamiera con predisposto il fissaggio alla base del torrino.

The counter base ensures an effective anchorage to the concrete support, through the fixing of four metal strips suitably designed. It is made in solid steel with arrangement for fixing to the fan base.

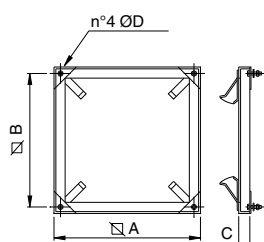

Code	Tipo   Type	∇A	∇B	C	ØD	Kg
1CB2000	CB 20	290	265	30	M8X30	1,5
1CB3000	CB 25	390	360	30	M8X30	2,5
1CB3000	CB 31	390	360	30	M8X30	2,5
1CB3500	CB 35	490	450	30	M8X30	2,8
1CB4000	CB 40	630	600	30	M8X30	3,2



**BA** | BASE D'APPOGGIO PER TORRINI | SUPPORT BASE FOR ROOF FANS

**DESCRIZIONE** - Le basi d'appoggio BA e la riduzione RD sono adatte per l'installazione dei nostri torrini su coperture costruite in lastre ondulate, evitando dannosi ristagni d'acqua attorno al ventilatore e costose opere murarie o di carpenteria. La base d'appoggio BA è utilizzabile per torrini aventi basamento da 930x930. Con l'apposita riduzione RD è possibile utilizzare la base per basamenti di torrini fino ad un minimo di 500x500. La riduzione RD è un unico elemento dove con un semplice taglio si elimina la parte eccedente.

**VERSIONI**

- BA 10x177 (Cod. 5PL1008) La base è accoppiabile a lastre tipo "EURO" passo 177 mm, altezza 51 mm e pendenza falda pari al 10%.
- BA 3x177 (Cod. 5PL1015) La base è accoppiabile a lastre tipo "EURO" passo 177 mm, altezza 51 mm e raggio di curvatura lastra pari a 3 metri.
- BA 10x146 (Cod. 5PL1009) La base è accoppiabile a lastre tipo "INTERNAZIONALE" passo 146 mm, altezza 48 mm, pendenza falda pari al 10%.
- Riduzione RD (Cod. 5PL1010).

**COSTRUZIONE** - In resine poliestere rinforzato con fibra di vetro stratificato. La finitura è RAL 9002 (grigio chiaro). La superficie esterna è trattata per resistere nel tempo agli agenti atmosferici.

**POSA IN OPERA** - Una posa corretta prevede la sovrapposizione alla lastra di copertura a valle e una sottoesposizione a monte. Inoltre è da prevedere una sovrapposizione laterale di almeno un'onda e un quarto per lato.

**DESCRIPTION** - The support base BA and reduction RD are suitable for installation of roof fans on waved coverings, avoiding detrimental stagnation of water near to the fan and expensive carpentry works. The support base BA is suitable for roof fans having base 930 x 930 mm or bigger. With the suitable reduction RD it is possible to use the base for roof fans from a minimum base dimension of 500x500. The reduction RD is a single element that can be easily cut to fit the exact fan dimension.

**VERSION**

- BA 10x177 (Cod. 5PL1008): suitable for "EURO" roof coverings pitch 177, height 51 mm and 10% slope.
- BA 3x177 (Cod. 5PL1015): suitable for "EURO" roof coverings pitch 177 mm, height 51 mm and radius of curvature of the sheet of 3 meters.
- BA 10x146 (Cod. 5PL1009): suitable for "INTERNATIONAL" roof coverings pitch 146 mm, height 48 mm, and 10% slope.
- Reduction RD (Cod. 5PL1010).

**CONSTRUCTION** - In polyester resins strengthen with stratified fibre glass. The finishing is RAL 9002 (light grey). The external surface is treated against the action of atmospheric agent.

**INSTALLATION** - A correct fitting foresees the overlap to the covering slab downstream and the underexposure upstream. Furthermore it must be foreseen a side overlap of at least one and quarter wave for each side.

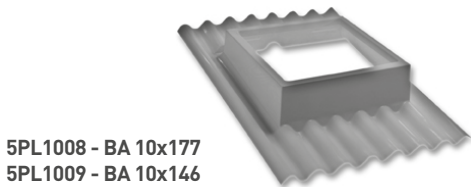

5PL1008 - BA 10x177  
5PL1009 - BA 10x146

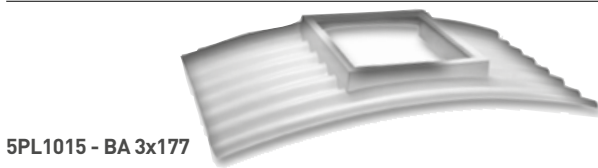
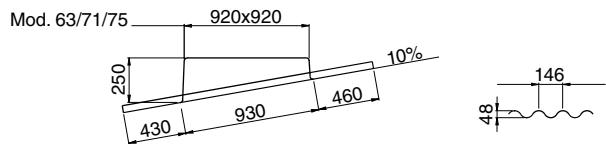

5PL1015 - BA 3x177

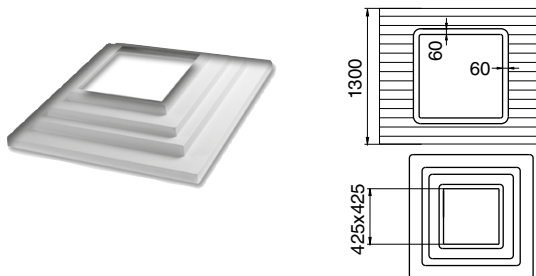
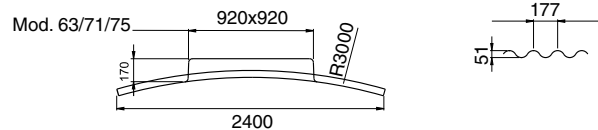

5PL1010 - RD

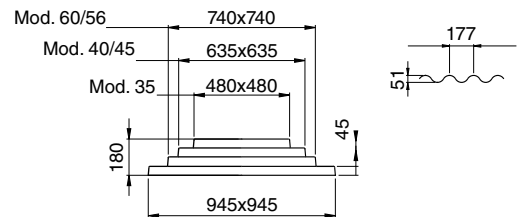

Dimensioni in mm | Dimensions in mm

**PB** | BASE D'APPOGGIO/ RIDUZIONE SILENZIATA  
PURLING BOX

La base d'appoggio/riduzione silenziata (PB), o purling box, è adatta per l'installazione dei nostri torrini su coperture piatte ed è comprensiva di isolamento acustico dal lato aspirazione del torrino. Struttura in lamiera zincata. Rivestimento fonoassorbente bugnato all'interno.

The silenced support base (PB) purling box is suitable for the installation of roof fans on flat covering. This support contains an acoustic isolation to reduce the noise of the fans at the inlet side support. Base frame in galvanized steel sheet. Internally lined with acoustic material.

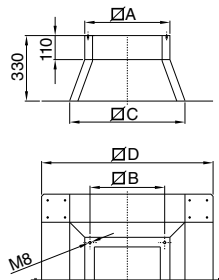

Code	Tipo   Type	ØA	ØB	ØC	ØD
5PB3100	25/31	380	360	520	780
5PB3500	35	480	450	620	880
5PB4000	40/45	630	600	770	1030

Dimensioni in mm | Dimensions in mm

**CCr** | RETE PROTEZIONE BOCCA ASPIRANTE  
INLET PROTECTION GUARD

Salvaguardano dal contatto accidentale con le parti in movimento del ventilatore. Realizzate in filo d'acciaio, a norma UNI 12499 e protette contro gli agenti atmosferici.

They prevent from casual contact with moving parts of the fan. Manufactured in steel rod according to UNI 12499 standard and protected against atmospheric agents.

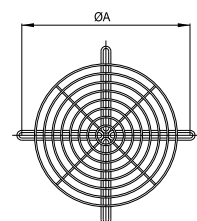

Code	Tipo   Type	ØA	Kg
5RE9032	CCr 25	450	0,8
5RE9041	CCr 31	500	1,0
5RE9051	CCr 35	560	1,4
5RE9064	CCr 40	620	2,0

Dimensioni in mm | Dimensions in mm