



AC-A - Boccaglio raggato in aspirazione
Shaped cone on inlet side



AC-B - Boccaglio raggato in aspirazione e mandata
Shaped cone on inlet and outlet sides

ErP 2009/125/CE



UE 1253/2014

Conformi

alla Direttiva ErP e al
Regolamento UE 327/2011 (FAN)

Comply

with ErP Directive and
EU Regulation 327/2011 (FAN)

A RICHIESTA UPON REQUEST

- Girante con pale a profilo alare in lega d'alluminio.
- Flusso dell'aria da girante a motore (solo AC-B).
- Impeller with airfoil blades in die-cast aluminium alloy.
- Airflow from impeller to motor (only AC-B).

AC-A - AC-B

Aspiratori assiali a telaio quadro Plate mounted axial fans



DESCRIZIONE

Gli aspiratori della serie AC sono adatti per la ventilazione nelle più svariate applicazioni civili, industriali e commerciali in cui siano richieste elevate portate d'aria con aspirazione non canalizzata. Sono utilizzabili come componenti (OEM) in una vasta gamma di applicazioni. Con l'aggiunta della piastra di fissaggio, il ventilatore (dalla taglia 710 alla 1250) si trasforma in un ventilatore assiale da parete (come la gamma QC). La serie è costituita da 2 versioni: AC-A ed AC-B, con diametro girante da 300 a 1250 mm e con differenti polarità. L'AC/A ha il boccaglio raggato solo in aspirazione mentre l'AC-B anche sulla mandata. L'impiego della serie AC è previsto con aria pulita, nell'intervallo di temperatura da -15°C a +50°C.

Il boccaglio ottimizzato in aspirazione riduce il rumore e aumenta l'efficienza aeraulica.

COSTRUZIONE

- Anello in lamiera d'acciaio verniciato a polveri epossipoliesteriche.
- Girante con pale a profilo alare in nylon-vetro e mozzo in fusione di lega d'alluminio. Angolo di calettamento variabile da fermo tramite tasselli di regolazione. Bilanciata secondo ISO 1940.
- Esecuzione 4 (accoppiamento diretto con girante a sbalzo). Flusso dell'aria da motore a girante.
- Rete di protezione lato motore in tondino d'acciaio trafilato saldata sull'anello. Realizzata a norme UNI 12499.

MOTORIZZAZIONI

Motore asincrono trifase o monofase a norme internazionali IEC 60034, IEC 60072, EMC 2014/30/UE, LVD 2014/35/UE e marcato CE IP55, classe F.

Idoneo ad un servizio S1 (funzionamento continuo a carico costante).

ACCESSORI

- CCR - Rete di protezione lato girante, realizzata a norme UNI 12499 solo per versione AC/B
- Piastra quadra per fissaggio a muro in lamiera verniciata a polveri epossipoliesteriche.

DESCRIPTION

The fans of the AC series are suitable for the ventilation in residential, commercial and industrial buildings in which are requested relevant air deliveries without canalization. They are also suitable as OEM in a wide variety of applications.

With the addition of a suitable wall mounting square frame adaptor, the AC fans (from size 710 to 1250) can be converted in a wall mounted fan (like QC range).

The series includes 2 versions: AC-A and AC-B, with impeller diameter from 300 a 1250 mm and different motor polarity. The AC-A model has a shaped cone in the inlet side, while for the AC-B the shaped cone is present also on the outlet. They are designed for clean air in the temperature range -15°C +50°C.

The optimized inlet cone reduces noise level and increases the efficiency.

CONSTRUCTION

- Ring frame in steel sheet protected against the atmospheric agents by epoxy paint.
- Axial impeller with aerofoil profile blades in glass reinforce polyamide and die-cast aluminium hub, balanced according ISO 1940. Variable pitch angle in still position with setting means.
- Execution 4 (impeller directly coupled to motor shaft). Air flow from motor to impeller.
- Inlet protection guard in steel rod directly welded on the ring frame, according to UNI12499 norm.

MOTOR

Asynchronous three-phase or single-phase motors according to international standards IEC 60034, IEC 60072, EEMC 2014/30/UE, LVD 2014/35/UE, CE marked, IP 55, class F. Service S1 (continuous working to constant load).

ACCESSORIES

- CCR - Impeller side protection guard, according to UNI 12499 norm only for AC-B.
- Wall mounting square frame adaptor in epoxy painted steel sheet.

PRESTAZIONI | PERFORMANCE

AC-A | AC-B

Le prestazioni aerauliche sono rilevate in conformità alla norma EN ISO 5801/AMCA 210 con densità dell'aria standard avente peso specifico 1,2 Kg/m³. Conformi alla Direttiva ErP 2009/125/CE e al regolamento UE327/2011. Categoria di misura: C. Categoria di efficienza: Statica. Alimentazione 230V/1Ph/50Hz o 400V/3Ph/50Hz. Air performances measured according to EN ISO 5801 / AMCA 210 standard with air density with 1.2 kg/m³ specific weight. Compliant with ErP 2009/125/EC Directive and EU Regulation 327/2011. Measurement category: C. Efficiency category: Static. Power supply 230V/1Ph/50Hz or 400V/3Ph/50Hz.

Lp Livello di pressione sonora rilevato in condizioni di campo libero, propagazione emisferica, categoria di misura C a norma EN ISO 13349, nel punto di massimo rendimento, alla distanza di 3 metri dal lato aspirazione e si presenta solo per fini comparativi. Sound pressure level measured in free field conditions, propagation hemispherical, measurement category C in accordance with EN ISO 13349, at the point of maximum efficiency at a distance of 3 meters, inlet side (for comparative purposes only).

Lw Livello di potenza sonora ottenuto secondo norma ISO 3746. Tolleranza +/- 3 dB(A). Sound power level obtained in accordance with EN ISO 3746. Tolerance +/- 3 dB(A).

AC 300

Code	Tipo Type	Modello Model	Ventola Impeller	U	P	P (kW)	In (A)	IP/CL	IE3	Mot. (Gr)
1AC0034	AC-A	312	3H-4-25	T	2	0,25	0,65	55/F	-	63
1AC2030	AC-B									
1AC0033	AC-A	314	DY-6-45	M	4	0,09	1,10	55/F	-	56
1AC2033	AC-B									
1AC0032	AC-A	314	DY-6-45	T	4	0,09	0,35	55/F	-	56
1AC2032	AC-B									

LIVELLI SONORI | SOUND LEVELS dB(A)

Hz	63 125 250 500 1000 2000 4000 8000 TOT															
	Lw	Lp	Lw	Lp	Lw	Lp	Lw	Lp	Lw	Lp						
AC 312	57	40	68	51	75	58	83	66	84	67	83	65	82	77	90	72
	41	24	51	34	56	39	62	45	65	48	65	48	66	43	71	54

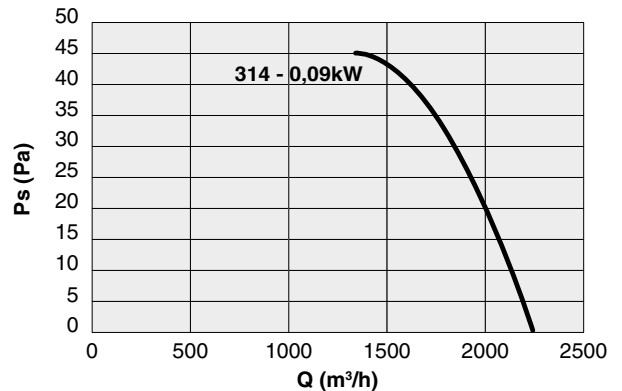
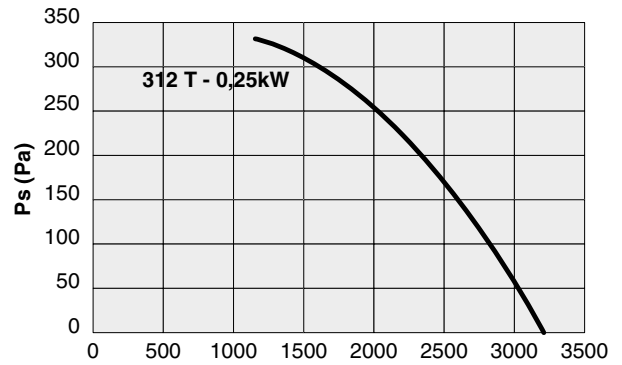

AC 350

Code	Tipo Type	Modello Model	Ventola Impeller	U	P	P (kW)	In (A)	IP/CL	IE3	Mot. (Gr)
1AC0035	AC-A	352	DY-6-30	T	2	0,55	1,35	55/F	-	71
1AC2035	AC-B									
1AC0038	AC-A	354	DY-6-45	M	4	0,12	1,10	55/F	-	63
1AC2038	AC-B									
1AC0037	AC-A	354	DY-6-45	T	4	0,12	0,45	55/F	-	63
1AC2037	AC-B									

LIVELLI SONORI | SOUND LEVELS dB(A)

Hz	63 125 250 500 1000 2000 4000 8000 TOT															
	Lw	Lp	Lw	Lp	Lw	Lp	Lw	Lp	Lw	Lp						
AC 352	57	40	68	51	74	57	79	62	82	65	82	66	83	78	88	71
	42	25	52	35	57	40	63	46	66	49	66	49	66	44	72	54

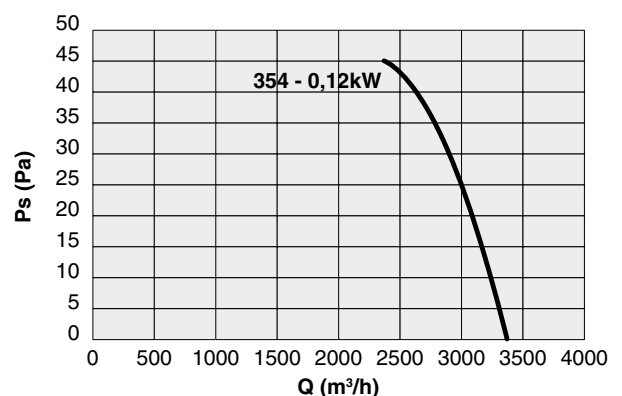
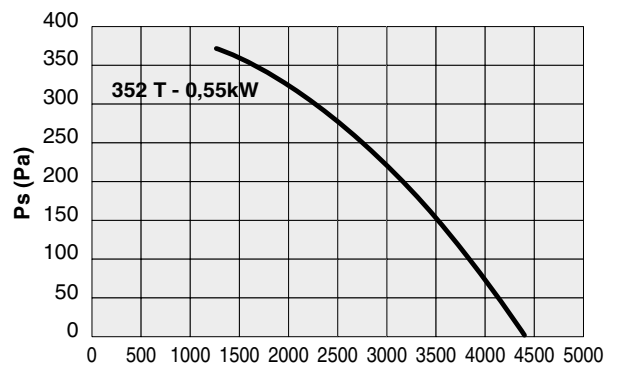

sez.
1.2

AC-A | AC-B aspiratori | fans

AC 400

CodE	Tipo Type	Modello Model	Ventola Impeller	U	P	P (kW)	In (A)	IP/CL	IE3	Mot. (Gr)
1AC0040	AC-A	402	DY-6-30	T	2	1,1	2,50	55/F	✓	80
1AC2040	AC-B									
1AC0000	AC-A	404	DY-6-30	M	4	0,12	1,10	55/F	-	63
1AC2000	AC-B									
1AC0001	AC-A	404	DY-6-30	T	4	0,12	0,45	55/F	-	63
1AC2001	AC-B									

LIVELLI SONORI | SOUND LEVELS dB(A)

Hz		63	125	250	500	1000	2000	4000	8000	TOT
AC 402	Lw	57	68	73	79	83	83	87	77	90
	Lp	40	51	56	62	66	66	70	60	73
AC 404	Lw	42	53	58	64	67	68	68	62	74
	Lp	25	36	41	47	50	51	51	45	56
AC 404	Lw	42	53	58	64	67	68	68	62	74
	Lp	25	36	41	47	50	51	51	45	56

AC 450

CodE	Tipo Type	Modello Model	Ventola Impeller	U	P	P (kW)	In (A)	IP/CL	IE3	Mot. (Gr)
1AC0078	AC-A	452	DY-6-30	T	2	1,5	3,00	55/F	✓	80
1AC2058	AC-B									
1AC0046	AC-A	454	DY-6-45	T	4	0,37	1,25	55/F	-	71
1AC2046	AC-B									

LIVELLI SONORI | SOUND LEVELS dB(A)

Hz		63	125	250	500	1000	2000	4000	8000	TOT
AC 452	Lw	62	72	78	85	89	88	88	82	94
	Lp	45	55	61	68	72	71	71	65	77
AC 454	Lw	50	57	62	67	69	70	70	65	76
	Lp	33	40	45	50	52	53	53	48	58

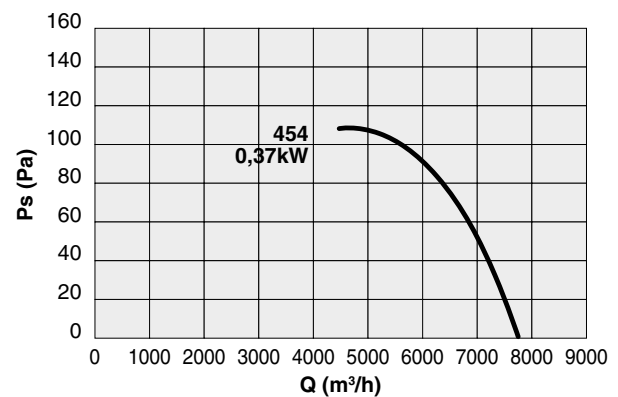
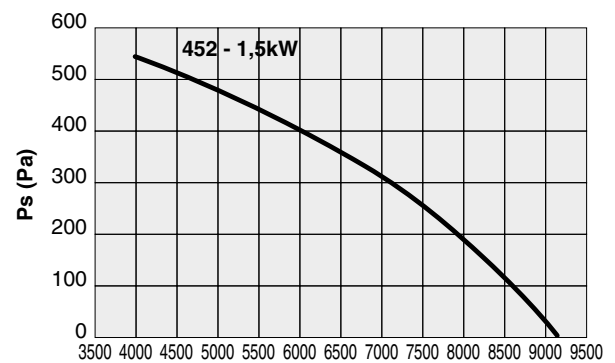
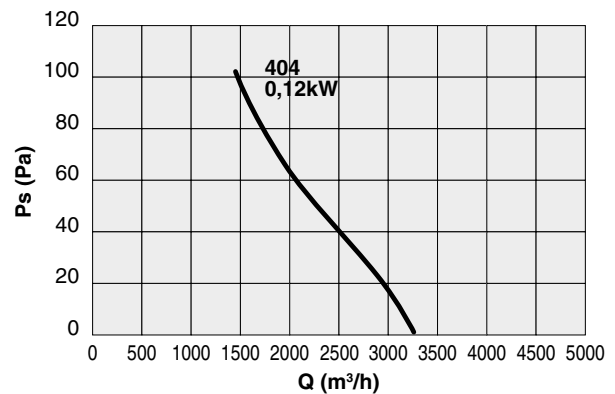
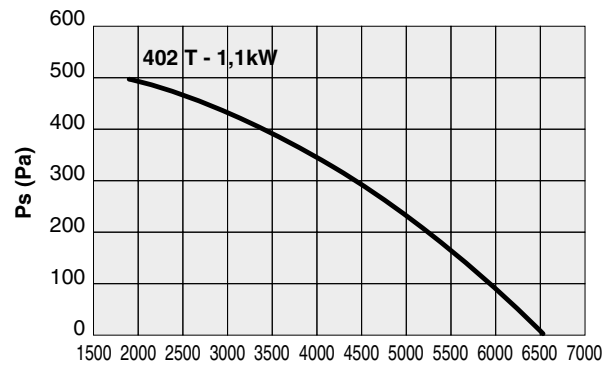

AC 500

Code	Tipo Type	Modello Model	Ventola Impeller	U	P	P (kW)	In (A)	IP/CL	IE3	Mot. (Gr)
1AC0079	AC-A	504	VS-8-30	T	4	0,55	1,60	55/F	-	80
1AC2050	AC-B									
1AC0003	AC-A	508	VS-8-35	T	8	0,12	0,71	55/F	-	71
1AC2003	AC-B									

LIVELLI SONORI | SOUND LEVELS dB(A)

Hz		63	125	250	500	1000	2000	4000	8000	TOT
AC 504	Lw	54	65	74	75	76	74	73	63	82
	Lp	37	48	57	58	59	57	56	46	64
AC 508	Lw	38	45	50	55	58	58	56	50	63
	Lp	21	28	33	38	41	41	39	33	46

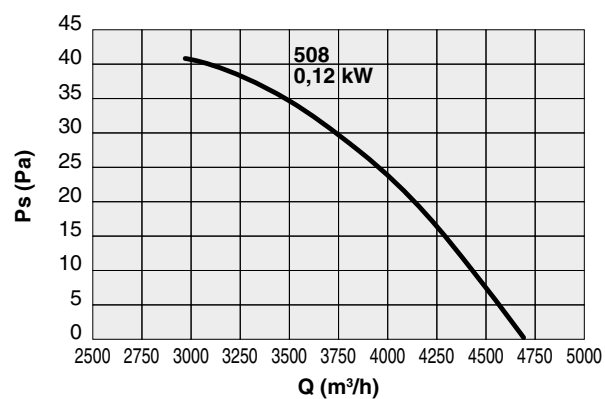
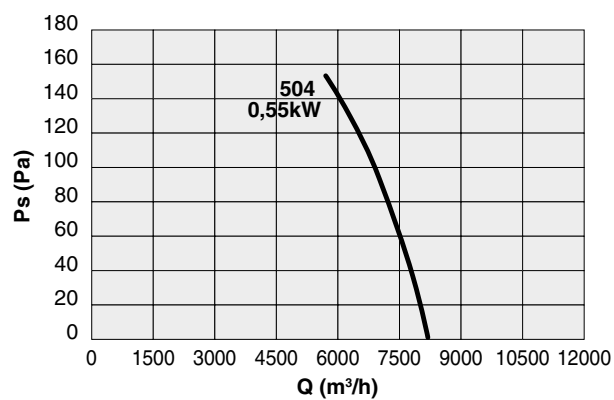

AC 560

Code	Tipo Type	Modello Model	Ventola Impeller	U	P	P (kW)	In (A)	IP/CL	IE3	Mot. (Gr)
1AC0065	AC-A	564	VS-8-30	T	4	0,75	2,10	55/F	✓	80
1AC2053	AC-B									
1AC0007	AC-A	566	3H-6-45	T	6	0,25	1,00	55/F	-	71
1AC2002	AC-B									
1AC0004	AC-A	568	VS-8-35	T	8	0,12	0,71	55/F	-	71
1AC2004	AC-B									

LIVELLI SONORI | SOUND LEVELS dB(A)

Hz		63	125	250	500	1000	2000	4000	8000	TOT
AC 564	Lw	55	62	67	72	75	75	73	67	80
	Lp	38	45	50	55	58	58	56	50	63
AC 566	Lw	56	63	67	70	70	69	68	62	76
	Lp	39	46	50	53	53	52	51	45	59
AC 568	Lw	48	55	60	62	63	62	61	55	69
	Lp	31	38	43	45	46	45	44	38	52

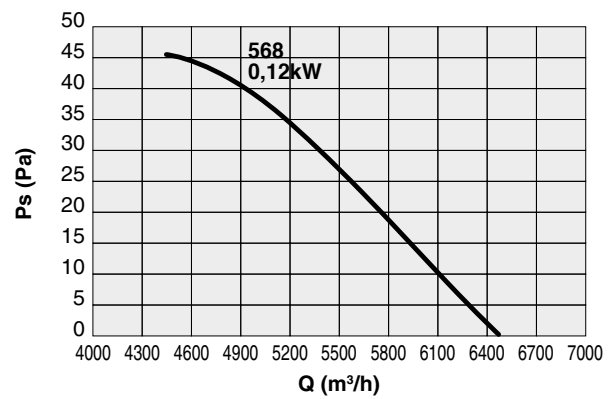
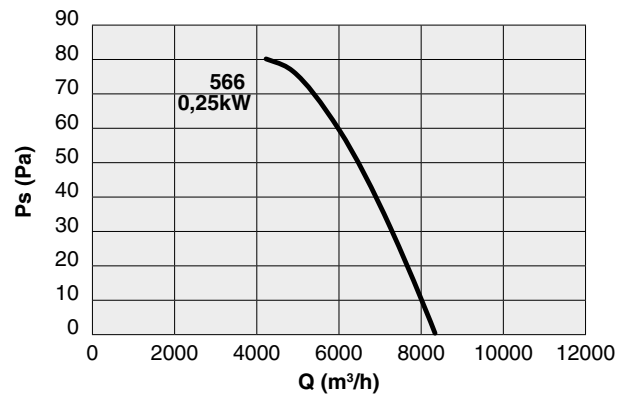
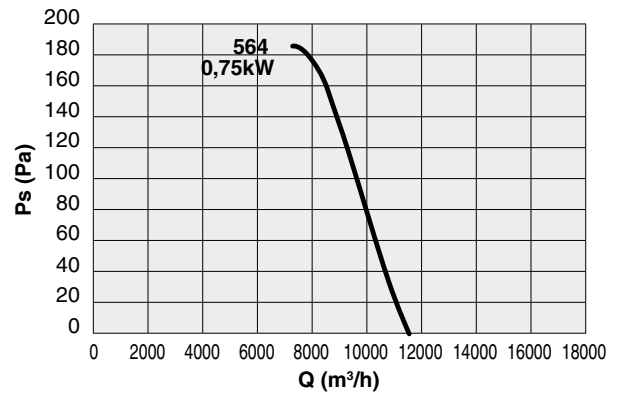

AC 630

Code	Tipo Type	Modello Model	Ventola Impeller	U	P	P (kW)	In (A)	IP/CL	IE3	Mot. (Gr)
1AC0088	AC-A	634	VS-8-30	T	4	1,1	2,50	55/F	✓	90
1AC2060	AC-B									
1AC0005	AC-A	636	VS-8-35	T	6	0,37	1,40	55/F	-	80
1AC2005	AC-B									
1AC0006	AC-A	638	3H-10-45	T	8	0,25	1,20	55/F	-	80
1AC2006	AC-B									

LIVELLI SONORI | SOUND LEVELS dB(A)

Hz		63	125	250	500	1000	2000	4000	8000	TOT
AC 634	Lw	57	64	69	74	77	76	75	69	82
	Lp	40	47	52	57	60	59	58	52	65
AC 636	Lw	55	62	67	69	70	70	69	63	77
	Lp	38	45	50	52	53	53	52	46	59
AC 638	Lw	46	56	61	63	65	64	64	58	71
	Lp	29	39	44	46	48	47	47	41	54

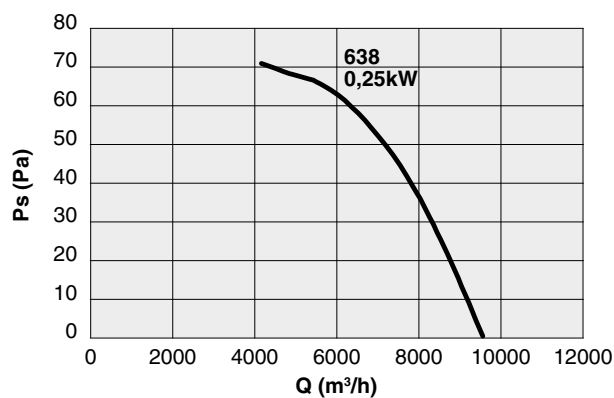
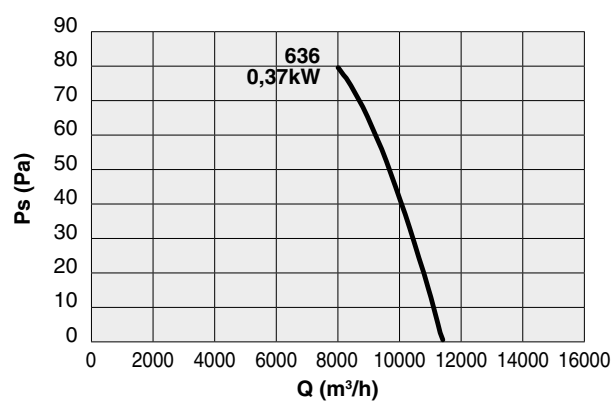
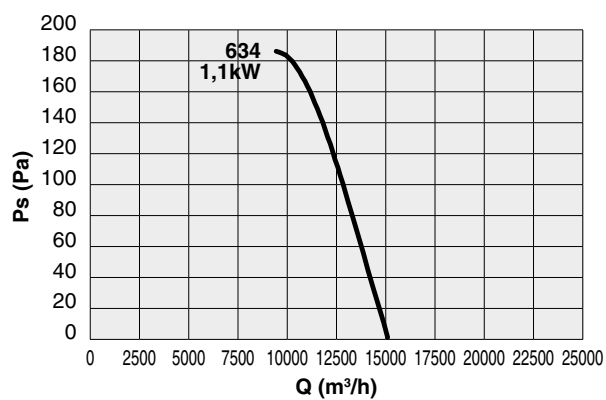

AC 710

Code	Tipo Type	Modello Model	Ventola Impeller	U	P	P (kW)	In (A)	IP/CL	IE3	Mot. (Gr)
1AC0070	AC-A	714	DY-8-40	T	4	2,2	4,60	55/F	✓	100
1AC2070	AC-B									
1AC0075	AC-A	716	DY-8-40	T	6	0,75	2,00	55/F	✓	90
1AC2075	AC-B									
1AC0076	AC-A	718	DY-8-40	T	8	0,37	1,40	55/F	-	90
1AC2076	AC-B									

LIVELLI SONORI | SOUND LEVELS dB(A)

Hz		63	125	250	500	1000	2000	4000	8000	TOT
AC 714	Lw	65	72	77	79	81	81	81	75	87
	Lp	48	55	60	62	64	64	64	58	70
AC 716	Lw	56	63	68	71	73	72	72	66	79
	Lp	39	46	51	54	56	55	55	49	62
AC 718	Lw	49	59	64	66	68	67	66	61	74
	Lp	32	42	47	49	51	50	49	44	57

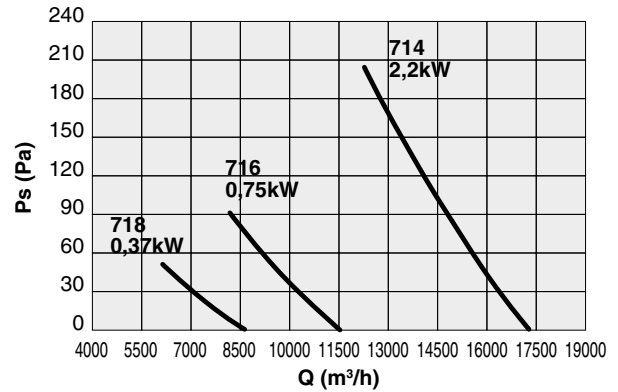

AC 800

Code	Tipo Type	Modello Model	Ventola Impeller	U	P	P (kW)	In (A)	IP/CL	IE3	Mot. (Gr)
1AC0080	AC-A	804	VS-10-23	T	4	4	8,10	55/F	✓	112
1AC2080	AC-B									
1AC0081	AC-A	806	VS-10-23	T	6	1,5	3,50	55/F	✓	100
1AC2081	AC-B									
1AC0087	AC-A	808	VS-10-23	T	8	0,55	1,90	55/F	-	90
1AC2087	AC-B									

LIVELLI SONORI | SOUND LEVELS dB(A)

Hz		63	125	250	500	1000	2000	4000	8000	TOT
AC 804	Lw	61	71	76	84	86	87	86	80	92
	Lp	44	54	59	67	69	70	69	63	75
AC 806	Lw	54	64	70	76	78	78	77	70	84
	Lp	37	47	53	59	61	61	60	53	66
AC 808	Lw	56	67	73	75	73	72	71	64	80
	Lp	39	50	56	58	56	55	54	47	63

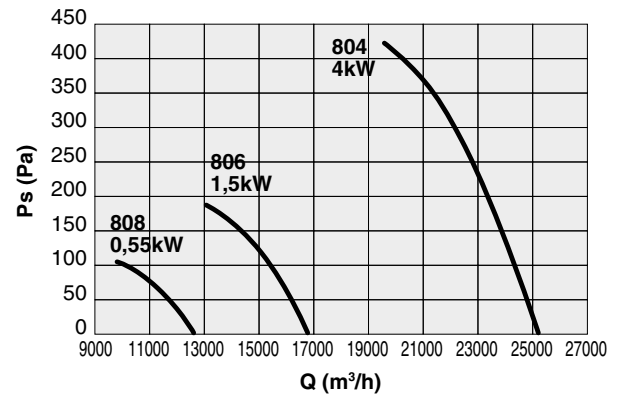

AC 900

Code	Tipo Type	Modello Model	Ventola Impeller	U	P	P (kW)	In (A)	IP/CL	IE3	Mot. (Gr)
1AC0097	AC-A	904	VS-10-23	T	4	7,5	14,40	55/F	✓	132
1AC2097	AC-B									
1AC0091	AC-A	906	VS-10-23	T	6	2,2	5,00	55/F	✓	112
1AC2091	AC-B									
1AC0098	AC-A	908	VS-10-23	T	8	1,1	3,40	55/F	✓	100
1AC2098	AC-B									

LIVELLI SONORI | SOUND LEVELS dB(A)

Hz		63	125	250	500	1000	2000	4000	8000	TOT
AC 904	Lw	65	76	82	88	90	89	88	81	95
	Lp	48	59	65	71	73	72	71	64	78
AC 906	Lw	58	69	76	79	81	80	78	72	86
	Lp	41	52	59	62	64	63	61	55	69
AC 908	Lw	57	64	69	72	74	73	72	63	80
	Lp	40	47	52	55	57	56	55	46	63

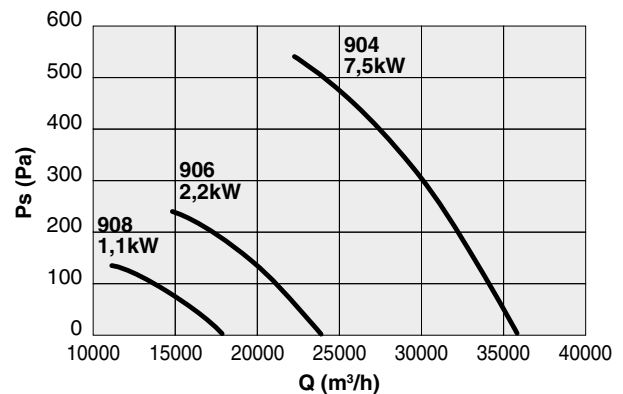

AC 1000

Code	Tipo Type	Modello Model	Ventola Impeller	U	P	P (kW)	In (A)	IP/CL	IE3	Mot. (Gr)
1AC0102	AC-A	1004	VS-10-23	T	4	9,2	17,60	55/F	✓	132
1AC2104	AC-B									
1AC0100	AC-A	1006	VS-10-23	T	6	4	8,10	55/F	✓	132
1AC2100	AC-B									
1AC0101	AC-A	1008	VS-10-23	T	8	1,5	4,00	55/F	✓	112
1AC2101	AC-B									

LIVELLI SONORI | SOUND LEVELS dB(A)

Hz		63	125	250	500	1000	2000	4000	8000	TOT
AC 1004	Lw	68	81	87	91	93	92	90	83	98
	Lp	51	64	70	74	76	75	73	66	81
AC 1006	Lw	60	73	79	83	84	83	81	74	90
	Lp	43	56	62	66	67	66	64	57	72
AC 1008	Lw	53	65	72	76	78	76	75	68	83
	Lp	36	48	55	59	61	59	58	51	65

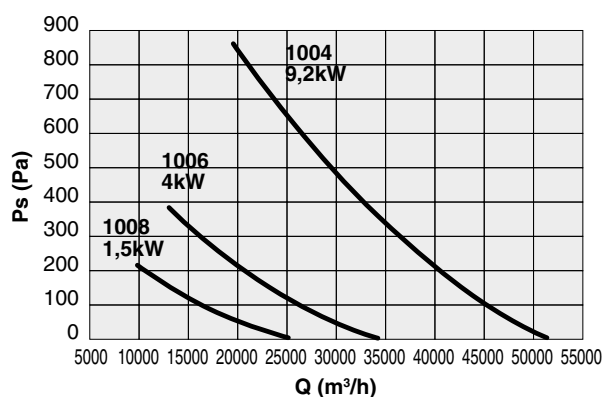

AC 1120

Code	Tipo Type	Modello Model	Ventola Impeller	U	P	P (kW)	In (A)	IP/CL	IE3	Mot. (Gr)
1AC0112	AC-A	1126	NH-10-30	T	6	5,5	11,10	55/F	✓	132
1AC2112	AC-B									
1AC0113	AC-A	1128	NH-10-30	T	8	2,2	5,5	55/F	✓	132
1AC2113	AC-B									

LIVELLI SONORI | SOUND LEVELS dB(A)

Hz		63	125	250	500	1000	2000	4000	8000	TOT
AC 1126	Lw	71	78	84	86	88	86	84	75	93
	Lp	54	61	67	69	71	69	67	58	76
AC 1128	Lw	64	76	85	83	83	80	78	69	90
	Lp	47	59	68	66	66	63	61	52	73

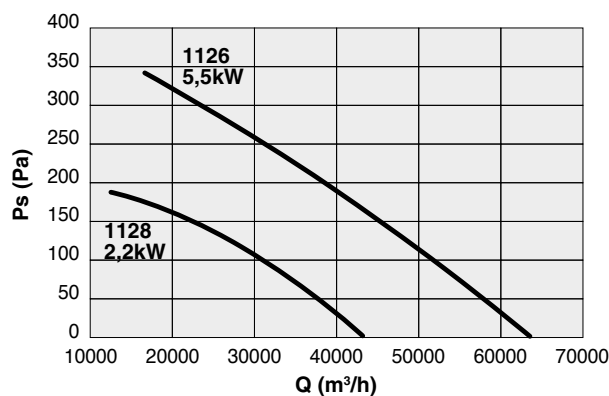

AC 1250

Code	Tipo Type	Modello Model	Ventola Impeller	U	P	P (kW)	In (A)	IP/CL	IE3	Mot. (Gr)
1AC0125	AC-A	1256	NH-10-30	T	6	7,5	24,80	55/F	✓	160
1AC2125	AC-B									
1AC0126	AC-A	1258	NH-10-30	T	8	3	7,3	55/F	✓	132
1AC2126	AC-B									

LIVELLI SONORI | SOUND LEVELS dB(A)

Hz		63	125	250	500	1000	2000	4000	8000	TOT
AC 1256	Lw	71	79	85	89	92	91	90	85	97
	Lp	54	62	68	72	75	74	73	68	80
AC 1258	Lw	62	69	75	81	84	84	83	77	90
	Lp	45	52	58	64	67	67	66	60	73

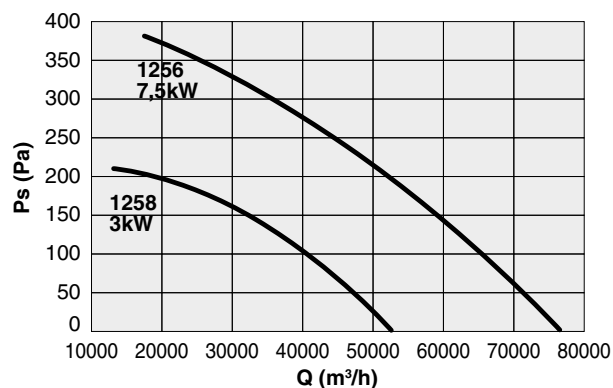

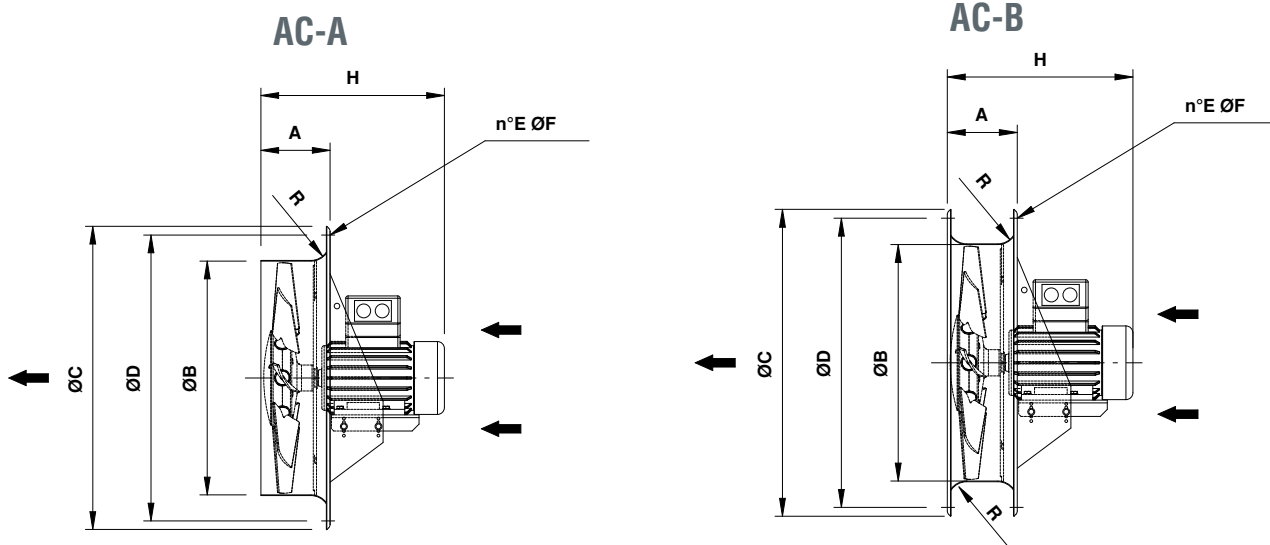

AC

Tipo Type	A	ØB	ØC	R	ØD	n°E	ØF	H	kg*
AC 310	175	307	442	35	395	8	10	300	12
AC 350	175	357	492	35	450	8	12	320	15
AC 400	175	407	546	35	500	8	12	380	17
AC 450	175	457	598	40	560	12	12	390	23
AC 500	190	507	658	40	620	12	12	420	25
AC 560	190	567	730	50	690	12	12	450	28
AC 630	190	637	810	50	770	16	12	470	35
AC 710	230	708	910	70	860	16	12	500	45
AC 800	250	808	1025	70	970	16	16	550	53
AC 900	300	910	1125	70	1070	16	16	660	70
AC 1000	300	1010	1245	70	1190	20	16	700	105
AC 1120	300	1130	1380	85	1320	20	16	720	118
AC 1250	300	1260	1525	85	1470	20	16	750	150

Pesi indicativi | Indicative weights



CCr | RETI PROTEZIONE | PROTECTION GUARDS

Salvaguardano dal contatto accidentale con le parti in movimento del ventilatore. Realizzate in filo d'acciaio, a norma UNI 12499 e protette contro gli agenti atmosferici.
CCr: versione piana.

They prevent from casual contact with moving parts of the fan. Manufactured in steel rod according to UNI 12499 standard and protected against atmospheric agents.
CCr: flat version.

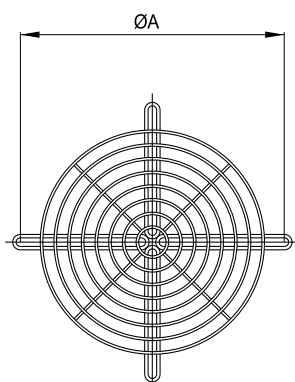

Code	Tipo Type	ØA	kg
5RE9036	CCr x AC - B 31	395	0,6
5RE9041	CCr x AC - B 35	450	0,7
5RE9046	CCr x AC - B 40	500	1
5RE9051	CCr x AC - B 45	560	1,4
5RE9057	CCr x AC - B 50	620	2
5RE9064	CCr x AC - B 56	690	2,2
5RE9072	CCr x AC - B 63	770	2,7
5RE9083	CCr x AC - B 71	860	4
5RE9093	CCr x AC - B 80	970	5
5RE9101	CCr x AC - B 90	1070	5
5RE9102	CCr x AC - B 100	1190	6
5RE9110	CCr x AC - B 112	1320	9
5RE9113	CCr x AC - B 125	1470	12

Dimensioni in mm | Dimensions in mm

PIASTRA FISSAGGIO | FIXING PLATE

Facilita l'installazione a parete
Eases the wall installation

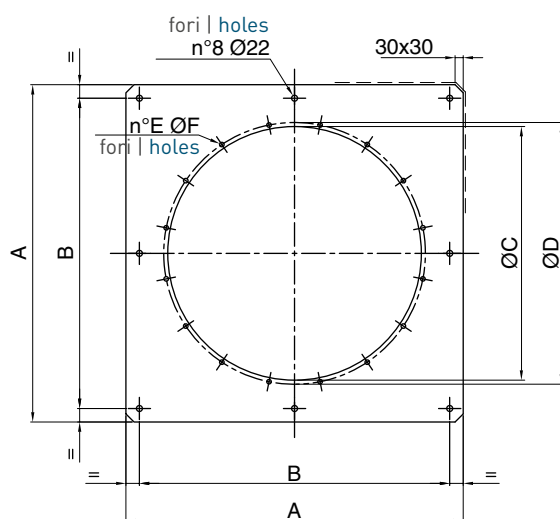

Code	Tipo Type	A	B	ØC	ØD	n°E	ØF	Sp	kg
5PP0030	31	650	550	365	395	8	13	30/10	8
5PP0035	35	750	650	420	450	8	13	30/10	10
5PP0041	40	750	650	470	500	8	13	30/10	9
5PP0045	45	800	700	530	560	12	13	30/10	10
5PP0051	50	860	760	590	620	12	13	30/10	11
5PP0056	56	930	830	660	690	12	13	30/10	13
5PP0063	63	1000	910	740	770	16	13	30/10	14
5PP0071	71	1120	1020	830	860	16	13	40/10	22
5PP0080	80	1210	1110	940	970	16	17	40/10	24
5PP0090	90	1320	1210	1040	1070	16	17	40/10	28
5PP2010	100	1420	1320	1140	1190	20	17	50/10	39
5PP0112	112	1570	1470	1270	1320	20	17	50/10	47
5PP0125	125	1720	1620	1420	1470	20	17	50/10	54

Dimensioni in mm | Dimensions in mm